

M286 (2.0)

(21.9)

TOYOTA

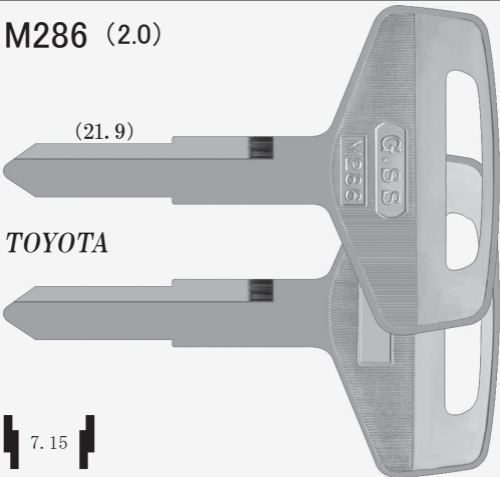

メーカー別 2-88P

溝別 P213